

NORTHSTAR⁺ AXIS 4.8

Specifications

Length	4.8 m. / 15'9"
Beam	2.23 m. / 7'3"
Weight	420 kg. / 925 lbs
Tube Diameter	0.46 m. / 18.1"
Suggested Tube Pressure	0.18 bar / 2.6 psi
No. of Chambers	4
Maximum Persons	8
Minimum Power	50 HP
Maximum Power	80 HP
Recommended Power	70 HP
Shaft Length	L
Fuel Tank Capacity	51 lt. / 13.5 US Gal
Design Category	CE - Cat. C

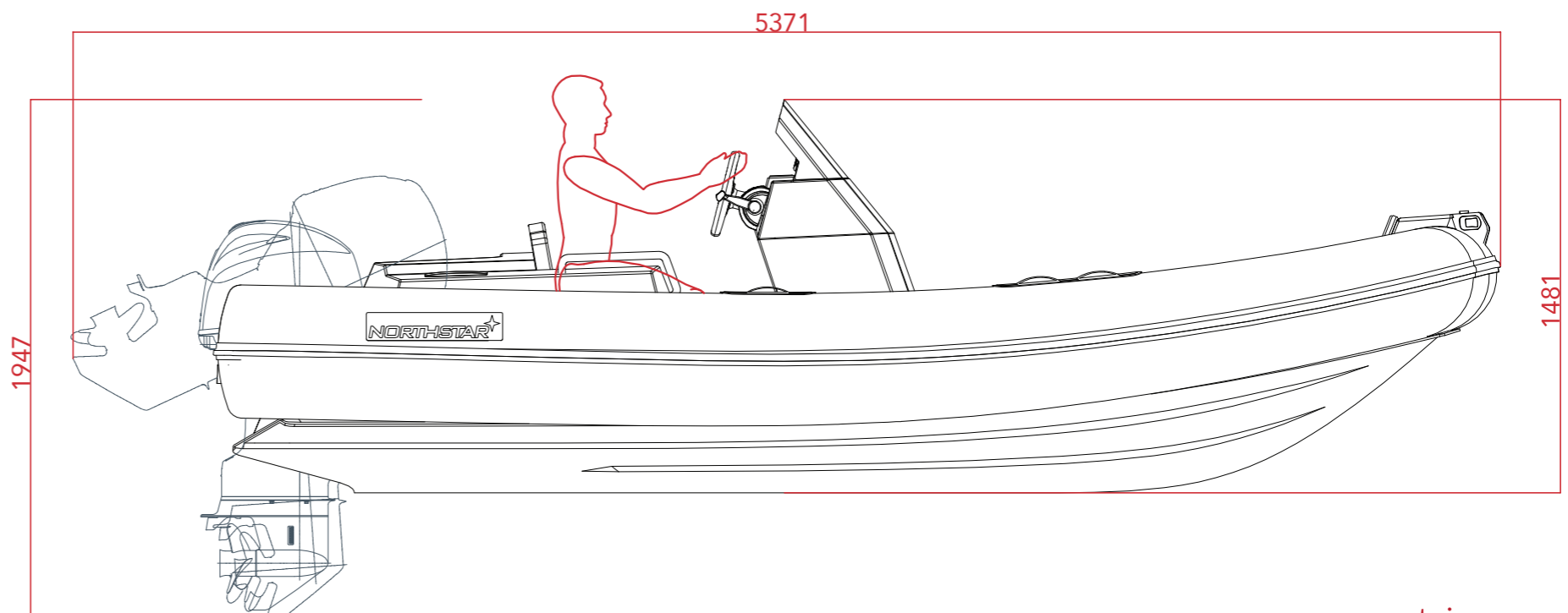
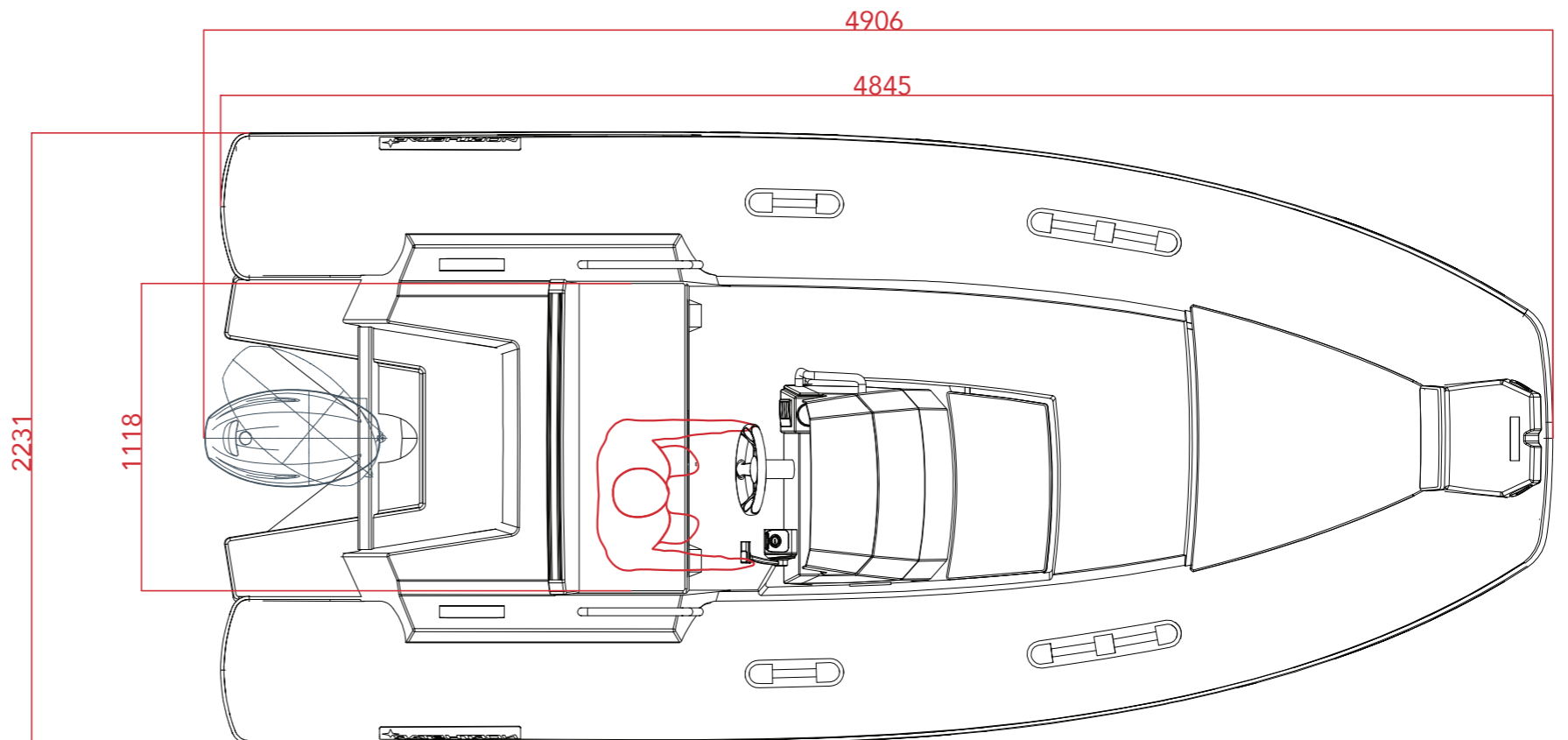

measurements in mm