

# NORTHSTAR<sup>★</sup> AXIS 3.1

## Specifications

Length	3.1 m. / 10'2"
Beam	1.81 m. / 5'11"
Weight	210 kg. / 462 lbs
Tube Diameter	0.40 m. / 15.7"
Suggested Tube Pressure	0.18 bar / 2.6 psi
No. of Chambers	3
Maximum Persons	4
Minimum Power	20 HP
Maximum Power	30 HP
Recommended Power	25 HP
Shaft Length	L
Fuel Tank Capacity	33 lt. / 8.7 US Gal
Design Category	CE - Cat. C

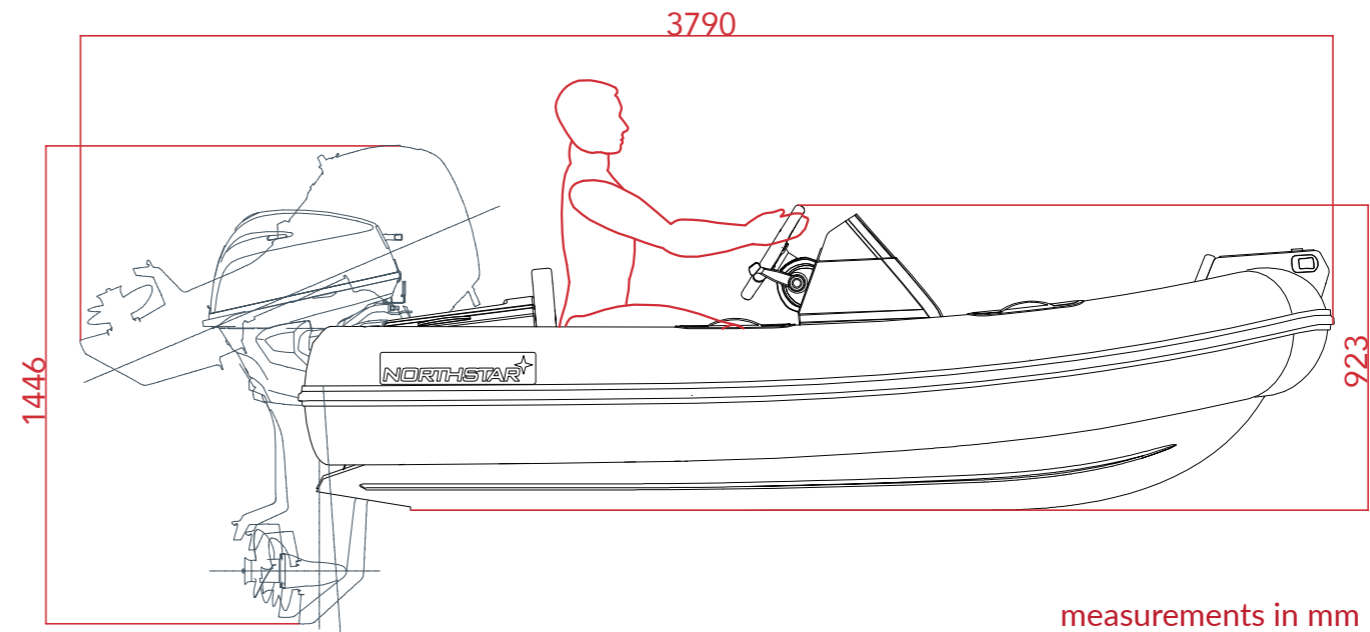
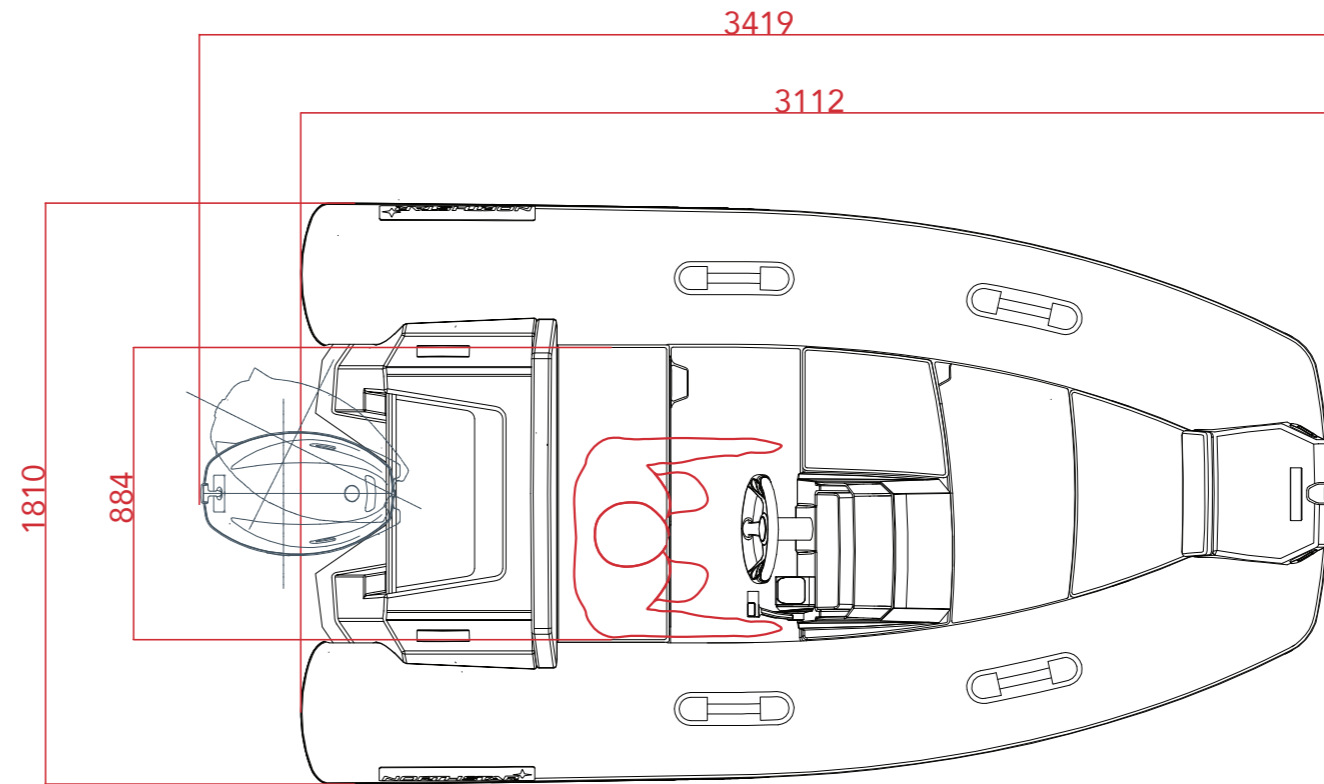

measurements in mm